

CI W Series Multi-function Counter User Manual

Features:

- Counting speed up to 20KCPS
- Free setting ratio 0.00001~999999
- Universal input. Choose "NPN" or "PNP" input through software.
- Batch or total accumulation function (except CI4W), optional 1 RS485 communication interface.
- Widely used in light industry, packaging, printing, textile, food and other industries for quantity and length counting.



Safety Caution

To use this product safely and correctly and to prevent serious accidents, please comply with the following points.

Safety Caution can be divided into two parts: "Warning" and "Caution", which means the following:

Warning Failure to follow this point can result in serious injury or injury.
Caution Failure to follow this point can result in injury or product damage.

The instruction of the symbol in the manual is as below.

Indicates that accidents or dangers may occur under special circumstances.

Warning

- Dual safety protection devices must be installed when used in machines that have a medium impact on people and property, such as: nuclear power control, medical equipment, vehicles, railways, aviation, combustion equipment, entertainment equipment, etc. Failure to do so may result in fire, death or property damage.
- Be sure to install the panel when using it, otherwise there is danger of electric shock.
- Do not perform maintenance work while the power is on, otherwise there is danger of electric shock.
- Do not modify this product without authorization, otherwise it may cause electric shock or fire.

Caution

- Do not use the product outdoors. Failure to do so may shorten the life of the product or cause an electric shock.
- When wiring the power input terminal and relay output terminal, please use the AWG NO.20 (0.50mm²) cable. The torque of the screw is kept at 0.7N.m~0.9N.m. If the contact is poor, it may cause a fire.
- Please use the product within the rated specifications. Otherwise, the life of the product will be shortened and there is a fire hazard.
- Please ensure the loading less than the allowable capacity of the relay contacts. Failure to do so may result in poor insulation, contact melting, poor contact, relay damage, fire, etc.
- Do not use water or organic solvents when cleaning. Wipe with a dry towel. Failure to do so may cause electric shock or fire.
- Avoid using this product in places that are flammable and explosive, humid, direct sunlight, heat radiation, vibration, etc. Failure to do so may cause a fire or explosion.
- Do not allow dust or cable residue to enter the inside of the product. Failure to do so may cause fire or damage to the product.

1. Model Illustration

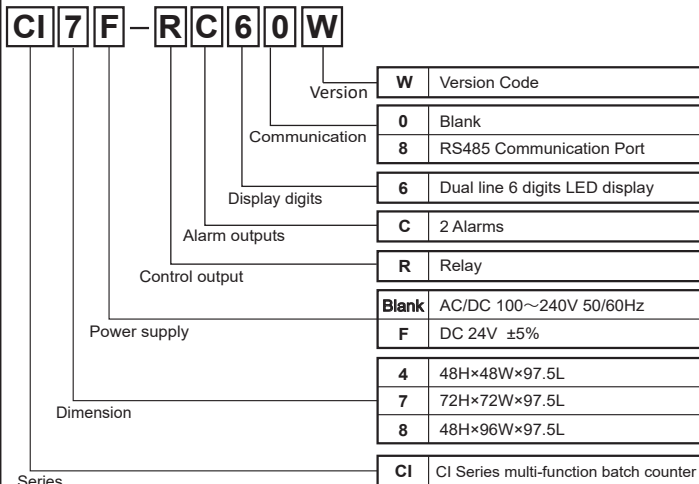

2. Model List

Model	Panel Size (mm)	Alarm output	Batch	Communication
CI4-RC60W	48H×48W	2	No	No
CI4-RC68W	48H×48W	2	No	RS485
CI7-RC60W	72H×72W	2	1 Relay	No
CI7-RC68W	72H×72W	2	1 Relay	RS485
CI8-RC60W	48H×96W	2	1 Relay	No
CI8-RC68W	48H×96W	2	1 Relay	RS485

3. Technical Specifications

Series	CI4W	CI7W	CI8W
Display digits	6	6	6
Text height	10mm	13mm	13mm
Setting value	7mm	9mm	6mm
Power Supply	High voltage type AC / DC 100-240V 50/60Hz Low Voltage type DC 24V ±5%		
Allowable voltage variation range	90~110% of the power supply voltage (high voltage type)		
Power Consumption	High voltage type Below 12VA Low Voltage type Below 10VA		
INA/INB max counting speed	1Hz、30Hz、1KHz、5KHz、10KHz、20KHz optional		
Minimum signal pulse width	INHIBIT, BATCH, RESET signal for option 1ms, 20ms		
Input type	Select voltage input mode or no voltage input mode - Voltage input mode: Input impedance: 5.4KΩ, "H" level voltage: 5-30VDC, "L" level voltage: 0-2VDC - No voltage input mode: input impedance: 1KΩ or less, short circuit residual voltage: 2VDC or less		
Time output delay	0.01~499.99s		
Control output	Contact capacity 250VAC 3A Resistive load SSR capacity below 30VDC, below 100mA		
External power supply	High voltage type: 24VDC ±10%, < 100mA Low voltage type: 12VDC, < 50mA		
Power failure memory	≥10 years		
Insulation resistance	> 100MΩ		
Withstand voltage	60 seconds below 2000VAC 50/60Hz		
Anti-interference (AC power)	±4KV interference square wave (amplitude 1us) generated by the analog jammer is applied between the power input terminals		
Vibration shock	Vibration resistant	10~55Hz (1 minute period) amplitude 0.75mm X, Y, Z 1 hour in each direction	
	Malfunction & impact resistance	10~55Hz (1 minute period) amplitude 0.5mm X, Y, Z 10 minutes in all directions 300m/s ² (30G)X, Y, Z, 3 times in each direction	
	Malfunction	100m/s ² (10G)X, Y, Z, 3 times in each direction	
Relay life	Mechanical	above 10 million times	
	Electric	above 100,000 times	
IP Grade	IP65 for panel		
Environment	Ambient temperature	-10~55, Storage: -25~65	
	Ambient Humidity	35~85%RH, Storage: 35~85%RH	
Certificate	CE		
Weight	about 159g	about 169g	about 253g

The surrounding environment must be in line with no ice, * no condensation. The weight here is the product net weight without packing.

4. Communication parameters

Communication Protocol	Modbus RTU (16bit CRC)
Communication type	RS485
Applicable specifications	EIA RS485 Standard
Maximum connection quantity	31pcs (communication add setting : 1~247)
Connection method	Two-wire half-duplex
Communication synchronization	Asynchronous
Communication effective distance	800m Max
Communication speed	2,400 / 4,800 / 9,600 / 19,200bps (Factory settings: 9,600bps)
Start bit	1 bit (fixed)
Data bit	8 bit (fixed)
Parity check	None, Even, Odd (Factory settings: None)
Stop bit	2bit

5. Panel Indication

① Measured value display (red LED)
 - Measurement status: Displays the count value (default). Displays the batch or total when the ACCUMULATION menu (ACCUM) is set to BATCH.1 or TOTAL.1.
 - Setting status: Display setting

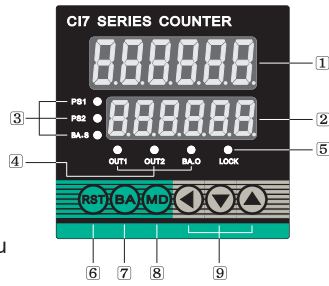

② Setting value display (green LED)
 - Measuring status: Display setting value (default). The counting value is displayed when the accumulation menu (ACCUM) is set to BATCH.1 or TOTAL.1.
 - Setting Status: Displays the contents of the settings.

③ Setting value indicator:
 When PS1 light is on: Displays the OUT1 setting value.
 When PS2 light is on: Displays the OUT2 setting value.
 When BA.S light is on: Displays the batch/total setting value.

④ When OUT1 light is on: the first counting output action.
 When OUT2 light is on: the second counting output action.
 When BA.O light is on: the batch/total output action.

⑤ Lock button indicator:
 When the lock function is selected through the LOCK menu, the indicator is always on.

⑥ Reset button:
 Press the **RST** button in the measurement state, the output is reset, and the counting value is reset to the initial value.

⑦ Batch button:
 - Short press the **BA** button in the measurement state to switch to the batch/total view mode. At this time, the BA.S light is on, the upper row shows the batch/total counting value, and the lower row shows the batch/total setting value.
 - Long press the **BA** button in the measurement state, and the batch/total counting value is reset to zero.
 * CI4 series products do not have batch/total counting function, no such button.

⑧ Function button:
 - Press the **MD** button in the measurement state to switch between the PS1 and PS2 settings.
 - Long press the **MD** button for 5S in the measurement state to enter the setting state.
 - Press the **MD** button while the measurement status or setting value is modified. Confirm that the current modification is saved and switch to the next menu.

⑨ Modify button:
 - In the measurement state, short press the **MD** button or the **BA** button to select the setting value to be modified. Press the **▲** button to enter the modification state of the current setting value (the LED flashes at this time), continue to press the **◀** button to make the flashing position moving left for one bit.
 - Short press the **▲** button in the setting state or setting value modification state to change the setting content or increase the flashing digit by one bit.
 - Short press the **▼** button in the setting state or setting value modification state to change the setting content or decrease the flashing digit by one bit.

6. Dimension

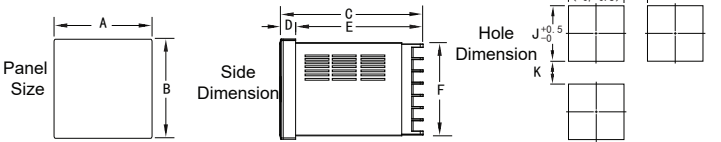

Model	A	B	C	D	E	F	G	H (Min)	J	K (Min)
CI4W:(48*48)	48	48	97.5	3	94.5	45	45.5	25	45.5	25
CI7W:(72*72)	72	72	97.5	3	94.5	67	67.5	25	67.5	25
CI8W:(48*96)	96	48	97.5	3	94.5	44.5	90	25	45	25

7. Input Connection

1. Product wiring diagram (if there is a difference with the instrument wiring diagram, please refer to the instrument wiring diagram)

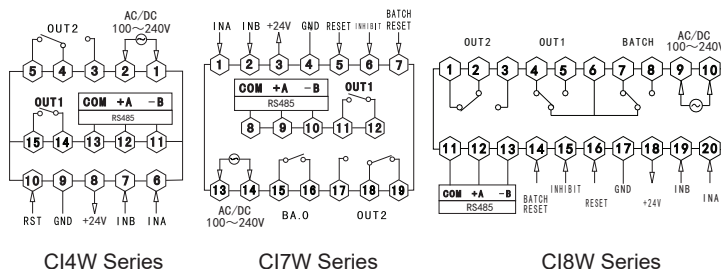

2. Input Connection

2-1. Input logic: no voltage input (NPN)

A. Solid state input (standard sensor: NPN output type sensor)

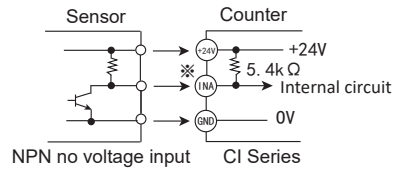

B. Contact access (counting speed should be set to 1cps, 30cps)

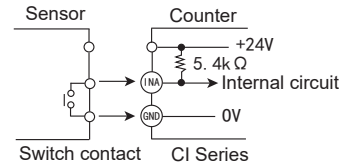

2-2. Input logic: voltage input (PNP)

A. Solid state input (standard sensor: NPN output type sensor)

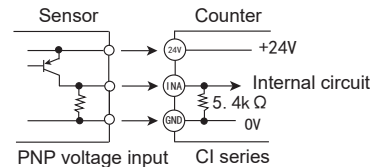

B. Contact access (counting speed should be set to 1cps, 30cps)

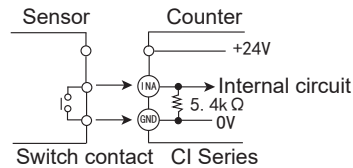

3. Output Connection

A. Relay output (standard)

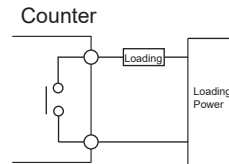

B. Transistor output (to be ordered)

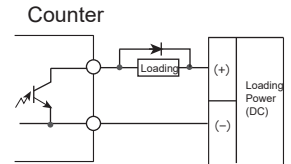

8. Menu operation

1. Menu state transition diagram

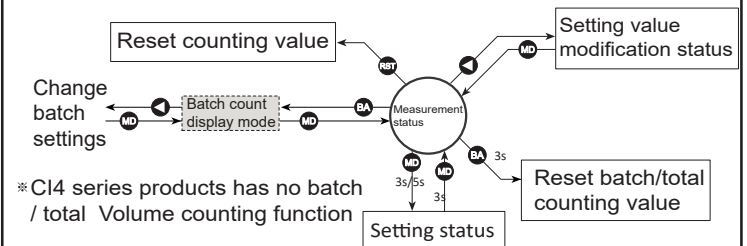

Remark 1) In the state of changing the preset value, if no button is pressed for 60 seconds, it will automatically return to the running state, and the setting data will not be saved.

2. How to change the 2nd way count setting (PS2) from 175 to 180

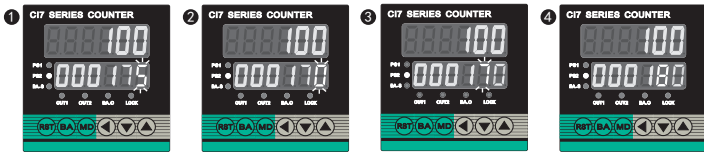

Press the **MD** button in the measurement state to make the PS2 light, press the **↑** button to enter the set value modification mode, and the lowest bit

Press the **↓** button to decrease the flashing digit value to 0.

Press the **←** button to flash the second digit

Press the **↑** button to add the flashing digit value to 8, press the **MD** button to confirm the change and exit the setting value modification mode.

3. Batch counting and its output action

3-1. How to change batch setting (BA.S) from 175 to 160

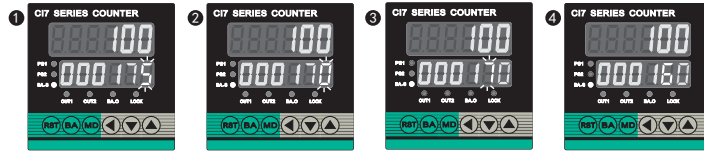

Press the **BA** button in the measurement state to make the BA.S light on, press the **↓** button to enter the setting value modification mode, and the lowest bit flashes.

Press the **↓** button to decrease the flashing digit value to 0.

Press the **←** button to flash the second digit

Press the **↓** button to decrease the flashing digit value to 6, press the **MD** button to confirm the change and exit the setting value modification mode.

3-2. Batch counting

- The batch counting value is accumulated upwards and can only be reset to zero by an external batch reset signal or by pressing the **BA** button.
- If the batch counting value exceeds 999999, it will automatically return to zero and restart counting.
- The batch count value is not affected by the **↓** button and the external count reset signal.
- Batch alarm output when the number of count alarm outputs is equal to the batch set value.

3-3. Batch output action

- If the batch output is ON. It will remain ON until the batch reset signal arrives.
- If the batch output is ON. The batch output should remain ON after the meter is powered off and re-powered, until the external batch reset signal arrives.

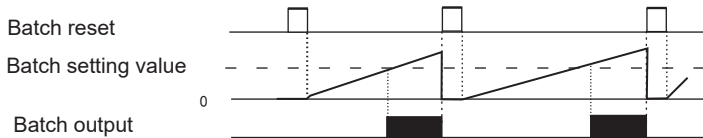

3-4. Batch counting application case

When the counting value reaches the preset value = 5, the counting value of the batch is increased by 1, and the product issues the control model (OUT) to the control box, send the filled box, and then send an empty box in the batch. The action is repeated until the processing batch reaches the target batch (200 batches). After the batch setting value = 200, the batch output is ON. After the conveyor receives the batch control signal, the loading is terminated, then issue a packaging signal for delivery.

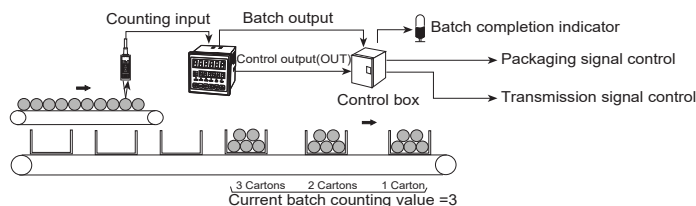

4. Menu flow and default settings

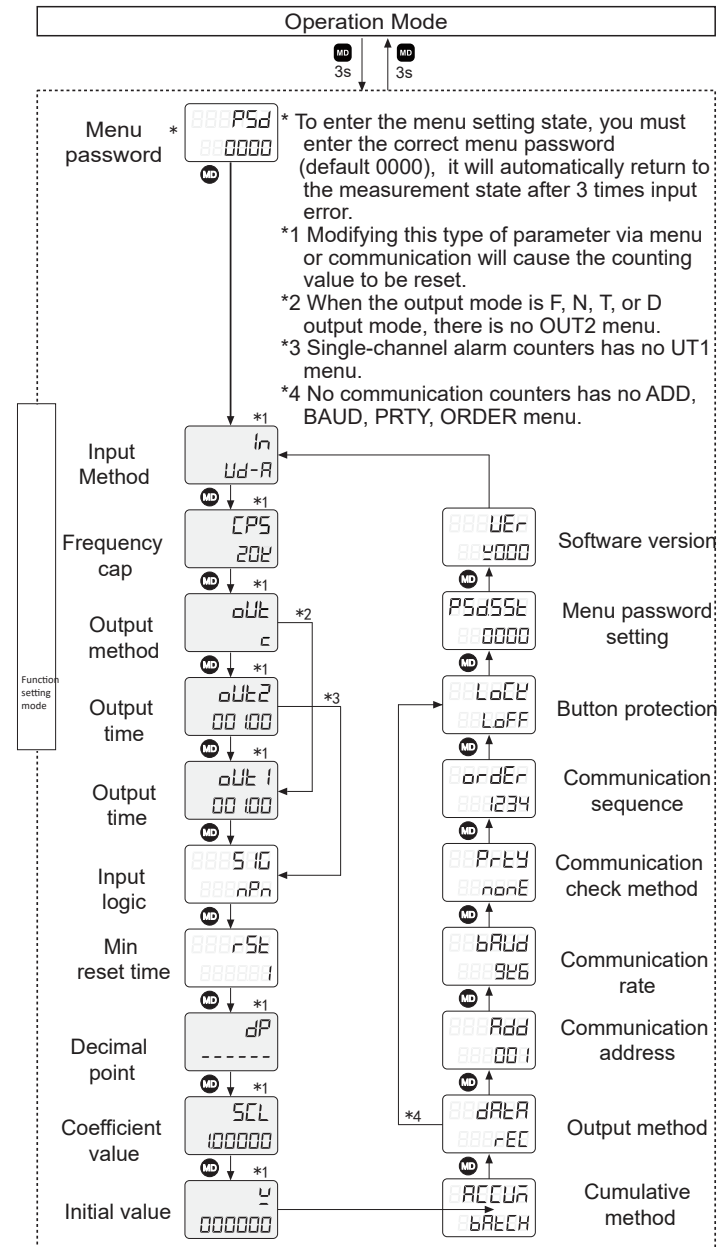

5. Ratio factor function

Ratio factor can set the multiple of each signal (pulse) to be converted into the actual length, flow, position, etc. The function of setting the multiple is called ratio factor function. If it is necessary to move any length L to P pulses, then the ratio factor = L/P.

For example: using a counter and a rotary encoder to control the length.

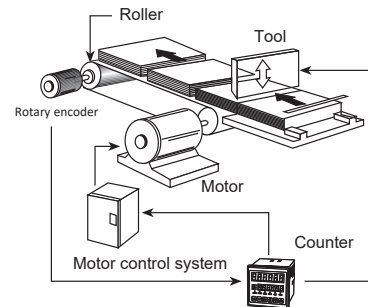

【The diameter (D) of the encoder roller is 22mm, and the number of pulses per encoder is 1000 pulse.】

$$\begin{aligned} \text{*Preset value} &= \frac{\pi \times \text{Diameter of the roller (D)}}{\text{Number of pulses per revolution of the encoder}} \\ &= \frac{3.1416 \times 22}{1000} \\ &= 0.069\text{mm/Pulse} \end{aligned}$$

In the function of decimal point setting mode, select one digit after the decimal point. (-----)
 In the function of setting mode, use (←, ↓, ↑) the left, down, and up keys to set and set to 0.069.
 This can adjust the position of the conveyor belt in 0.1mm units.

6. Menu Description

Setting Items	Setting content
Menu Password P5d	0000 → 9999 Enter the preset menu password before entering the menu setting state. If the password is wrong for 3 consecutive times, it will automatically return to the measurement state (initial password 0000)
Input Mode i _n	U → d → U d → U d - A → U d - B → U d - C If the output mode is S, T, D, the input mode can only select U d - A, B, C
Counting Speed CPS	1 → 30 → 1E → 5E → 10E → 20E The counting speed indicates the maximum input frequency allowed by INA and INB. If it is set to 5K, the input signal frequency exceeds 5K and the counting will be inaccurate.
Output Mode o _u t	※Up or Down input mode F → n → C → r → E → P → Q → R → n ※Up/Down - A, B, C input mode F → n → C → r → E → P → Q → R → S → E → d → n
Output Delay Time o _u t1 o _u t2	001 → 49999 o _u t1: OUT1 Output delay time setting menu (1 channel alarm product does not have this menu). Setting range: 0.01s-499.99s (more than 499.99 will display "HOLD"). At this time, OUT1 will keep output for a long time until the reset signal input or OUT2 delayed output ends. o _u t2: OUT2 Output delay time setting menu Setting range: 0.01s-499.99s
Input logic S _{IG}	n P n : NPN type sensor may have no voltage input. P n P : PNP type sensor or no voltage input
Min reset time r _S t	1 → 20 Minimum RESET Signal Width (Unit:ms)
Decimal point d _P	----- * Set the counting value and demical point of the setting value.
Coefficient value S _{CL}	0.00001 → 999999 RST button: change the demical point of coefficient value
Initial Value <u> </u>	-99999 → 999999 Initial value: count value after manual or automatic reset.
Batch accumulation and display mode R _{EC} L _U n	B _R E _C H : Accumulate by batch, batch count value and count value are displayed separately E _O T _R L : Accumulate by quantity, total count value and count value are displayed separately B _R E _C H 1 : Accumulate by batch, batch count value (upper row) and count value (lower row) are displayed at the same time E _O T _R L 1 : Accumulate by total number, total count value (upper row) and count value (lower row) are displayed at the same time
Power failure memory d _R E _R	C _L R _E ↔ r _E C C _L R _E : Count value reset after power off r _E C : Count value keeps after power off
Meter Address R _{Ad} d	1 → 247 The communication address of the counter can be set arbitrarily between 1-247
Baud rate b _R U _o	4800 → 9600 → 19200 Communication baud rate, Unit bps
Calibration method P _r E _T Y	n _o n _E → o _{dd} → E _V E _n n _o n _E o _{dd} E _V E _n :None :Odd :Even
Communication subsequence o _r d _E r	1234 → 4321 → 2143 Transmission order of communication data in words
Key Lock L _o C _k	L _o FF : The key lock function is off, and the LOCK light on the panel is off L _o C.1 : lock (key), the LOCK light on. L _o C.2 : lock (key), the LOCK light on. L _o C.3 : lock (key), the LOCK light on. i _n 1E ↔ L _o C.3 i _n 1E : Press (key), reset all menu data to factory values
Menu Password Setting P _S d _S E _t	0000 → 9999 Menu password change (Please record the changed password properly, otherwise you will not be able to enter the setup menu)
Software version V _E r	Software version for the counter meter

9. Input logic diagram

2. Input mode

Input mode	Counting Diagram	Description
U (Up)		※ When INA is counting input, INB stops counting input. When INB is counting input, INA stops counting input.
d (Down)		※ When INA is counting input, INB stops counting input. When INB is counting input, INA stops counting input.
U d - A (Up/Down-A)		※ INA: Counting input INB: Counting instruction input ※ When INB = "L", add "UP" to count When INB = "H", minus "DOWN" to count
U d - B (Up/Down-B)		※ INA: Input count up INB: Input count down ※ If INA, INB change from L to H at the same time, then maintain the previous count value.
U d - C (Up/Down-C)		※ When the A, B input phases of the encoder are connected to the counter INA, INB, please use the phase difference input (U d - C) in the counter input mode (in).

※ Ⓐ is above the minimum signal pulse width.
 Ⓑ is more than 1/2 of the minimum signal pulse width, and if it is below this signal pulse width, a count error of ± 1 will occur.

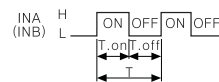

T.on, T.off: min signal pulse width.

※ Explanation of "H", "L" on the counting chart

Input method Letter	Voltage Input	Contactless input
H	5-30VDC	Short circuit (Short)
L	0-2VDC	Open circuit (Open)

※ Minimum signal pulse width for each counting speed 1cps=1 Hz

Counting Speed	Min signal pulse width
1cps	500ms
30cps	16.7ms
1kcps	0.5ms

Counting Speed	Min signal pulse width
5kcps	0.1ms
10kcps	0.05ms

3. Output Mode

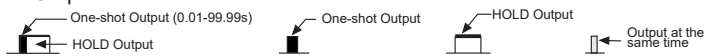

Output Mode	Up	Input Mode Down	UD - A, B, C	Description
F (F)				After count-up, counting display value increases or decreases until reset signal is applied and retained output is maintained.

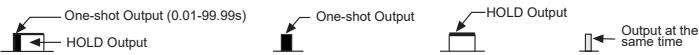

Output Mode	Input Mode			Description
	Up	Down	UD - A, B, C	
(N)				After count-up, counting display value will be reset and retained output are maintained until reset signal is applied.
(C)				When count-up, counting display value will be reset and count simultaneously. OUT1 retained output will be off after OUT2 one-shot time. The one-shot output time of OUT1 one-shot output time is operated regardless of OUT2 output.
(R)				After count-up, counting display value is reset after one-shot output time of OUT2 and it counts simultaneously. OUT1 retained output will be off after OUT2 one-shot time. OUT1 one-shot output time is operated regardless of OUT2 output.
(K)				After count up, counting display value increases or decreases until RESET input is applied. OUT1 retained output is off after OUT2 one-shot time. OUT1 one-shot output time is operated regardless of OUT2 output.
(P)				After count-up, counting display value is maintained while OUT2 output is on, Counting value is internally reset and counts simultaneously. When OUT2 output is off, displays counting value while OUT2 is ON, and it increases or decreases. OUT1 retained output is off after OUT2 one-shot time. OUT1 one-shot output time is operated regardless of OUT2 output.
(Q)				After count up, counting display value increases or decreases during OUT2 one-shot time. OUT1 retained output is off after OUT2 one-shot time. OUT1 one-shot output time is operated regardless of OUT2 output.

Simple troubleshooting of instrument

- The meter does not count or the counting is wrong
 - Check whether the connecting wire of the instrument is correct.
 - Check whether the input signal, level and frequency of the sensor are correct, and whether the output indicator of the sensor flashes with the working condition.
 - Check whether the input mode (IN) and counting speed (CPS) of the instrument meet the application requirements.
 - Check whether the ratio (coefficient) SCL is correct.
- The set value cannot be modified or the panel reset key does not respond
 - Check whether the LOCK key protection menu has selected the key protection function.
- The instrument displays "Error"
 - The scale factor SCL must be less than or equal to the set value of PS1 and PS2. Otherwise, the "Error" prompt will be displayed.
- The count value cannot be reset to 0
 - Check whether the initial value W is not equal to 0.

Installation Precautions

- When the power supply is ON/OFF:
 - The initial 100ms after power on is the power supply rising period, and 500ms after power off is the power supply falling period, which is an unstable period. Therefore, input signals after 100ms of power on, and power on again after 500ms of power off.
- Input signal cable
 - ①The distance from the detection sensor to our product should be as short as possible.
 - ②If you need a long input signal cable, please use a shielded cable.
 - ③Input signal cable, power cable and power cable shall be wired separately
- Contact input
 - If the contact is used in the counter high speed mode (1k, 5k, 10k, 20kcps), when there is counting input, the contact will vibrate when opening and closing, resulting in abnormal input signals and inaccurate counting. Therefore, the contact should be used in the low speed mode (1cps or 30cps).
- When installing the product on the control panel and conducting the withstand voltage and insulation impedance test:
 - ①Completely separate the circuit of this product from the control panel.
 - ②Short circuit all terminals of the product.
- Avoid using in the following places:
 - ①Places with strong vibration or impact
 - ②Places where strong acid and alkali substances are used
 - ③Places with direct sunlight
 - ④Near the machine where strong magnetic field and electronic interference occur
- Installation environment
 - ①Indoor
 - ②Pollution Degree 2
 - ③Below 2000m above sea level
 - ④Installation Category II

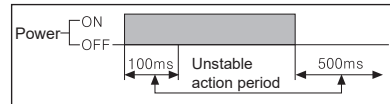

Communication protocol

- For the communication protocol, please refer to the General MODBUS-RTU Communication Protocol for Counting, Timing and Frequency Products, which can be obtained by contacting the sales.

Output Mode	Input Mode			Description
	Up/Down - A, B, C			
(A)				After count up, counting display value and OUT1 retained output are maintained until RESET input is applied. OUT1 one-shot output time is operated regardless of OUT2 output.
(M)				When display value=integral multiple of PS1, OUT1 output reset automatically after delay time. When display value=PS2, OUT1 output reset automatically after delay time, displayed value will return immediately to Initial state, output reset after setting time.
(S)				OUT1 and OUT2 keep on Status in following condition: Counting display value ≥ PRESET1 Counting display value ≥ PRESET2
(T)				OUT1 output is off: Counting display ≥ PRESET1 (when PRESET1 is 0, OUT1 output maintains ON state) OUT2 keeps ON status in following condition: Counting display value ≥ PRESET2
(D)				When counting display value is equal to setting value (PRESET1, PRESET2) only, OUT1 and OUT2 output keeps ON status. When setting 1kcps for counting speed, solid state relay output should be used.

※ The OUT output of the 1-segment counter meter is the same as the OUT2 output of the 2-segment counter meter
 ※ The preset value of OUT1, OUT2 cannot be set to 0 In all output modes.